



电手术台（99B型）

Electric Operating Table (Model 99B)



99B型

99B型电手术台由我公司引进国外先进技术自行研制开发，是一款高档次的多功能手术台，属国内领先产品。该手术台适用于胸腹外科、脑外科、五官科、妇产科、泌尿科、骨科等各类外科手术。

除常规功能外，99B型电手术台集多种功能和优点于一身：台面低位设计，可提供低位的手术要求；台面可前后平移及旋转，空间充裕，可在不移动病人的情况下，进行全身C型臂透视和影像检查，为医生进行透视和各种手术操作提供舒适位置；头板与背板间无横梁，可做颈椎透视；床面五段式结构，可形成V形和反V形复合体位；背板下折后可与座板形成反V形，利于肾脏手术，背板上折角度大，能形成坐姿，为方便坐姿脑手术所需；头板、脚板均可拆卸；并可选购不间断电源系统和自动水平复零系统，选配骨科牵引架。

该手术台性能优良，功能齐备，造型美观，操纵方便。床垫由高级PY发泡树脂材料制造，防静电。液压系统关键部件使用进口件，工作稳定可靠，噪音低。

主要规格 (Specifications)

全长 (Overall length)	2150mm
宽 (Width)	500mm
台面最高 (Max Height)	930mm
台面最低 (Min Height)	580mm
行程 (Adjust)	≥ 350mm

Electric operating table 99B is developed independently by our company with innovative and advanced technologies. The table is a first-class comprehensive one with high-quality and multi-purposes ,which takes the leading position in the domestic market. The table can be used in almost all kinds of operations such as abdominal surgery, neurosurgery, ENT, obstetrics and gynecology, urology, orthopedics and other types of surgery.

In addition to above-mentioned performance, electric operating table 99B integrates multi-purposes with advantages: low position design of tabletop meets the requirement of needed low position in the operation; adjustable tabletop, moveable in the longitudinal direction and rotation angle of tabletop. Conducting full-body imaging and perspective examination with C-arm without moving the patient for ample space, and providing doctors with comfortable positions for perspectives and surgical operations. No beam between head section and back section, cervical perspective; five-section structure, V-shaped, and anti-V-shaped composite position; Back section downward, anti-V-shape with sitting section, helpful to kidney surgery; back section upward, forming sitting position, to facilitate the brain surgery; detachable head and feet section, Option: uninterruptible power systems, and automatic re-set systems, Option: orthopedic traction table

Excellent performance, comprehensive functions, beautiful appearance, easy operation, the main body material is made from high-strength cast iron, aluminum, stainless steel; mattress is made of anti-static senior PY foam materials. Imported parts in hydraulic system, stable performance, low noise.





电动手术台（99C、2000L型）

Electric Operating Table (Model 99C、2000L)

99C电动手术台由我公司引进国外先进技术自行研制开发，是一款高档型的综合多功能手术台，属国内领先产品。超低位设计，能满足各种手术的需要，床面可纵向平移及水平旋转，台面采用高强度合成板制成，能透过X射线，可在手术过程中对病人进行全身各部位的C型臂检查。床垫由高级PY发泡树脂材料制造，防静电。

该手术台采用电动液压控制，操作简便、噪音低、性能稳定可靠。

2000L型电动手术台无床面纵向平移功能，其余各参数与99C型电动手术台相同。

This Electric Operating Table 99C is developed independently by our company with innovative and advanced technologies. The table is a comprehensive one with high-quality and multi-purposes, which takes the leading position in the domestic market. The table can be used in almost all kinds of operations by means of special design. The bedtop can be moved vertically and rotated horizontally. The tableboard is made from high-intensity synthesis panel, X-Ray transmissive, easy adjustment and easy use of C-arm make the table can be more capable for any operation. Anti-static Senior PY foam material is optional for mattress.

The operating table is controlled by Control Circuit, which is easy operation, low noise, reliable performance.

2000L operating table has almost the same functions with 99C, except that 2000L can't be moved in vertical direction.

主要规格 (Specifications)

全长 (Overall length)	2040mm
宽 (Width)	500mm
台面最高 (Max Height)	930mm
台面最低 (Min Height)	580mm
行程 (Adjust)	≥ 350mm

99C、2000L型





电动手术台 (99,99A,99A- I 型)

Electric Operating Table (Model 99,99A,99A- I)

电动手术台供医院手术室施行人体各部位手术用。该产品除具有国内原有手术台的所有功能外，还具有独特的优点：腿板既可折转、外展又可拆卸，调节方便，十分便利泌尿科手术；台面可作前后移动，且全部采用高强度塑料板制成，可进行射线诊查；该手术台采用24V直流电压，安全可靠，台面前后倾、左右倾、上下升降、前后移动均由电机实现，电钮操作，按照使用要求的不同，可同时配置各种不同功能的台面。

电动手术台的研制成功，填补了国内空白，是目前我国功能全、性能好、最先进的新型手术台之一。可配C型臂使用。

99A型背板上折、腿板下折采用气压弹簧。床垫可选用高级PY发泡树脂材料制造，防静电。

99A- I 型的台面升降、前后倾、左右倾、前后平移及腰板升降均由电机实现，电钮操作。

99A型



Electric Operating Table is designed for all operations in hospitals. Besides all functions of the domestic products, it has its own advantages:

1.Leg section can be rotated, opened, disassembled and adjusted easily.It is most adapt to the urological operation.

2.The table top,made of highstrength plastic, can move backwards and forwards. X-ray examination can be carried out on it.

3.With 24V direct supply,the table is safe and reliable. The table's elevation, lowering,reversed trendelenburg;trendelenburg,lateral tilt are all automatically controlled by the Button.

4.This table can be configured with different kinds of table tops for different use.

5.The ascending and descending movements, lateral tilt movements, reversed trendelenburg , trendelenburg movements and backward and forward movements of the table top are all electrically operated.

Electric Operating Table is one of the most advaced operating table with excellent functions in China.Available for the Model C arm.

The back section and the leg section of Model 99A is equipped with the barometric pressure spring.Anti-static Senior PY foam material is optional for mattress.

The ascending and descending movements, lateral tilt movements, reversed trendelenburg , trendelenburg movements , backward and forward movements and up-and-down of kidney section of model 99A- I are all electrically operated.

99型



99型主要规格 (Specifications)

长 (Length)	2100mm
宽 (Width)	480mm
台面最高 (Max Height)	1000mm
台面最低 (Min Height)	750mm

99A型主要规格 (Specifications)

长 (Length)	2100mm
宽 (Width)	500mm
台面最高 (Max Height)	1000mm
台面最低 (Min Height)	750mm

世界在变，创新不变！

CREATIVITY IS ETERNAL, BUT THE WORLD IS CHANGING.

电动手术台 (99D型)

Electric Operating Table (Model 99D)

本产品供医院手术室施行头、颈、胸腹腔、会阴及四肢等外科及妇产科、五官科、骨科等手术，台面升降、前后倾、左右倾及前后移动由电动系统完成，背板升降应用高压气体阻尼缸支撑结构，该床整个操作系统灵活、简便。全密封底座，造型美观大方，防尘防水，稳定实用，底座造型便于医师靠近患者，减少工作疲劳。台面采用高强度合成板制成，能透过X射线，便于透视、摄影。床垫由高级PY发泡树脂材料制造，防静电。可配C型臂使用。

该产品底座罩可选配不锈钢或玻璃钢。

The product is designed for head, neck, throat and abdomen, perineum as well as gynecology and obstetrics, orthopaedics and so on operations. The table's elevation, lowering, reversed trendelenburg; trendelenburg, lateral tilt are all automatically controlled by the Button, the back section elevation is controlled by high pressure gas jar. It can be adjusted easily. The airproof base is dustproof, waterproof and stable, its model is easy for doctor to near the patient, and reduces the doctor's weary. The table is made of high-strength synthetic boards, it can penetrate the X-ray, it is advantageous for the perspective and the photography. Anti-static Senior PY foam material is optional for mattress. It also can be used with C-arm.

Fiberglass reinforced plastic or Stainless steel is optional for the cover of base.



99D型

主要规格 (Specifications)

长 (Length)	2100mm
宽 (Width)	500mm
台面最高 (Max Height)	1000mm
台面最低 (Min Height)	750mm



电动手术台 (2000G、2000H型)

Electric Operating Table (Model 2000G、2000H)

2000G、2000H型电动手术台是本公司采纳、吸收国内外先进技术研制开发的新产品。该手术台适用于骨科、妇科、眼、耳、鼻、喉、泌尿科等各科手术，是当今世界领先产品。

该手术台由电动液压系统、控制电路及可透X线的台面组成，功能齐全，操作灵活。偏柱式支撑，可大面积透X射线，更好地配合C型臂来完成各种手术，五节式床面板，床身尺寸符合人体工程学，可以方便地调节出颈椎、腰椎、脊椎等手术所需要的各种体位。该手术台功能齐全，性能良好，是一款理想的手术设备。

Electric Operating Table 2000G、2000H was exploited independently by our company with innovative and advanced technologies introduced from domestic and overseas. This table can be used in almost all kinds of operation including orthopedics, otology, gynaecotokology, uriology ect. It is a world leading product.

This table is composed by electric Hydraulic pressure system, Control circuit and X-ray transmissive head section. Full function, easy adjustment, with the help of C-arm, the table can be more capable for any operation. The back section is made form five parts, which can be easily adjusted for different operations such as neck, lumber and chine operations. With the good performance, you will find it is a perfect operation equipment.

2000G型

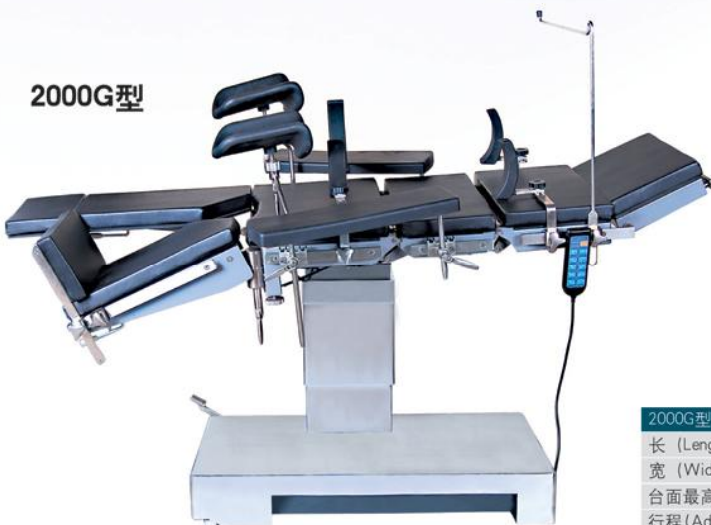

2000G型主要规格 (Specifications)

长 (Length)	2100mm
宽 (Width)	500mm
台面最高 (Max Height)	700~1000mm
行程 (Adjust)	≥300mm

2000H型

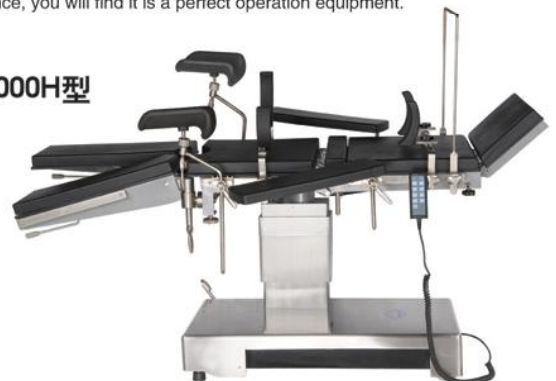

2000H型主要规格 (Specifications)

长 (Length)	2100mm
宽 (Width)	500mm
台面最高 (Max Height)	700~950mm
升距 (Adjust)	≥250mm



电动手术台（2000型）

Electric Operating Table (Model 2000)

供医院手术室施行头、颈、胸腹腔、会阴及四肢等外科及妇产科、五官科、骨科等手术。双层台面，可在手术时进行X射线检查；腿板可外展90°及拆卸，十分便于泌尿科手术。台面升降、前后左右倾、背板折转由电动装置实现，操纵灵活，安全可靠。床垫可选用高级PY发泡树脂材料制造，防静电。

This bed is designed for surgical procedures of head, neck, thorax and abdomen, perineum extremities as well as for gynaecological, oto-rhino-laryngological and orthopaedics operation. The table top, made of double-decker plastic. So that X-ray examination can be available during operation. It's raising, lowering, lateral tilt, reversed trendelenburg and trendelenburg movement, back section bending are all controlled by electrically. It can adjust easily, And its performance is also reliable. Anti-static senior PY foam material is optional for mattress.

主要规格 (Specifications)

长 (Length)	2100mm
宽 (Width)	480mm
台面最高 (Max Height)	1000mm
台面最低 (Min Height)	750mm

2000型



电动手术台（2000A型）

Electric Operating Table (Model 2000A)

2000A型



2000A电动手术台适用于头、颈、胸、腹腔、会阴、四肢等外科、妇产科、泌尿科、五官科、脑外科等手术需要。台面升降、侧倾、前后倾、背板折转、腿板折转、腰板升降均由电动实现，按钮操纵。床垫由高级PY发泡树脂材料制造，防静电。

electrical operating table 2000A is used in all the operations like head, neck, chest, abdomen, perineum, limbs and other surgeries, obstetrics and gynecology, urology, ENT, neurosurgery and so on. Adjustable height, trendelenburg and Reversed trendelenburg, tilt, folding movement of back section and leg section, up-and-down of kidney section are controlled by electric circuit. Mattress is made of anti-static senior PY foam materials.

主要规格 (Specifications)

长 (Length)	1980mm
宽 (Width)	500mm
台面最低高度 (Min Height)	620mm

世界在变，创新不变！

CREATIVITY IS ETERNAL, BUT THE WORLD IS CHANGING.



电动手术台（2000B型）

Electric Operating Table (Model 2000B)

该产品是我公司根据医院临床要求开发的一种新产品，尤其适合于眼科手术。

该手术台最大的特点是床面最低能降到500mm，便于医生做眼科手术时坐姿操作并设有搁手架以降低医生的疲劳程度；该手术台的升降采用电动机构实现，具有噪声低、可靠性强和操作方便的优点。

2000B型



It is a special designed new product for ophthalmology operation in need of hospital and clinical demands.

This operating table can be lowered to 500mm height from floor for the convenient of ophthalmologist. The table is equipped with hand rest for decreasing physical fatigue of doctor. Its raising and lowering actions are controlled by electrically. It works with lower noise and can be adjusted easily. And also has a reliable performance.

主要规格 (Specifications)

长 (Length)	1950mm
宽 (Width)	520mm
台面最高 (Max Height)	750mm
台面最低 (Min Height)	500mm



电动手术台（2000C型）

Electric Operating Table (Model 2000C)

该电动手术台是专为脑外科手术而设计，也可满足颈、胸腹腔、会阴、四肢等外科、妇产科、泌尿科、五官科手术的需要，是一种多功能的综合手术台。

该手术台的最大特点是床面可降得很低，尤其适用于医务人员坐位手术，并有成套的专用头架。

该手术台采用电动装置实现各动作，噪音低，性能稳定，操纵方便。可灵巧地调节台面、头板、背板、座板、腰板、腿板的各项预定的动作和角度。

2000C型

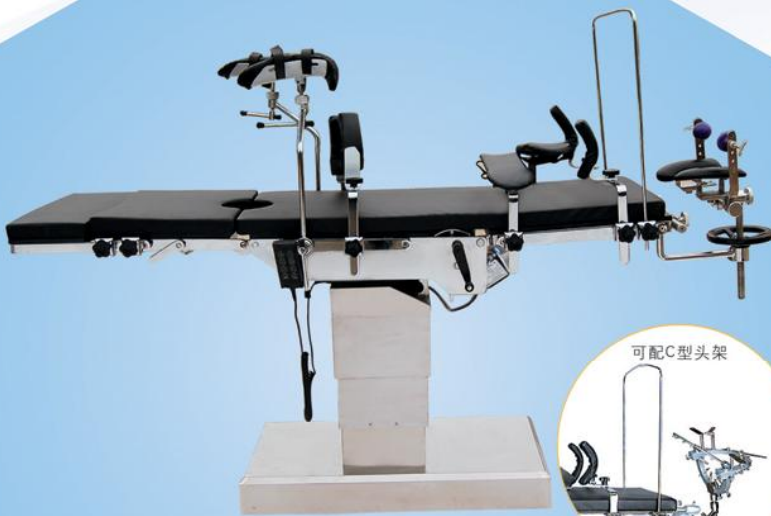

可配C型头架



It is a specially designed new product for cerebral operation, also available in surgical procedures of the neck, throat and abdomen, perineum and extremities as well as for gynaecological, oto-rhino-laryngological operations. It is a multi purpose operating table.

This operating table can be lowered to 550mm height from floor for convenient of doctors. There is also a special designed head rack.

Its movements are controlled by electrically. It has a lower noise, And its performance is also reliable, It can be adjusted easily. Various positions as head section, back section, seat section, kidney bridge, Leg section can also be easily adjusted.

主要技术参数 (Main Technical Parameters)

床面长度 (Length)	2000mm
床面宽度 (Width)	480mm
床面最高 (Max Height)	800mm
床面最低 (Min Height)	550mm



电手术台 (2000E型)

Electric Operating Table (Model 2000E)

电手术台主要适用于普外科的手术需要。2000E型电手术台台面升降、台面前后移动、左右移动由电动实现，按钮操纵，立柱侧置。

电手术台包括台面、主体、电控、附件等部分。台面可根据需要在主体上作前后移位和左右移位，前后位移量大于400mm，左右位移量大于100mm。台面采用高强度合成板制成，立柱侧置，以便于对病人进行X光透视。

Electric Operating Table (Model 2000E) is designed for surgical. The tabletop's raising, lowering, backward and forward movements, lateral movement are all conducted electrically and controlled by buttons. Pillar side is put.

Electric operating Table is consisted of the tabletop, the body, the electric controlling part and the accessories, etc. The tabletop can be moved backward and forward if necessary. The distance of moving backward can be more than 400mm. The distance of moved lateral is more than 100mm. The tabletop is made of high-strength synthetic boards, thus X-ray examination of can be available.

2000E型



主要规格 (Specifications)

台面尺寸 (Dimension of table top)	全长 (Overall Length)	2000mm
	宽 (Width)	550mm
台 高 (Table top Off from floor)	台面升降行程 (Throw of tabletop)	250mm
	台面离地最低 (Min Height)	700mm

世界在变，创新不变！

CREATIVITY IS ETERNAL, BUT THE WORLD IS CHANGING.



头部操纵式综合手术台（3008D、3008E型）

Multi-purpose Operating Table, Head controlled (Model 3008D、3008E)

3008D型头部操纵式综合手术台供胸外科、眼科、耳鼻喉科、妇产科和泌尿科等施行一般手术用。操作方便、灵活，是一台供临床使用理想的综合性手术设备。

该产品油泵内外罩及底座罩可根据用户需求选配工程塑料或不锈钢。

3008E型腿板可外展90°。

3008D is one multi function operating table for Thoracal, ophthalmology, gynaecology, urology operationect. It is a good all-round equipment for clinical use.

Plastics or Stainless steel is optional for the cover of oil pump and base.

Leg section of model 3008E can be opened 90°.

特点 (Character):

- ◆ 具有适用各种外科手术及检查的多功能手术台。
Suit for all surgery operating or examining.
- ◆ 采用集油泵油箱和传动机构于一体的脚踏液压泵。
It take hydraulic pump by footboard.
- ◆ 采用气缸控制台面的各个动作，操作方便、定位可靠。
It take cylinder to control each action, easy to operate and localize.
- ◆ 结构紧凑合理，造型新颖。
New configuration is more sound.
- ◆ 腰板为内置式，使用方便。
Built in waist section is easy to use.
- ◆ 床垫均为采用新型耐酸碱，易消毒材料。
Mattress is manufactured with anti-acid and alkali material.



3008D型



3008E型

主要规格 (Specifications)

长 (Length)	1990mm
宽 (Width)	480mm
台面最高 (Max Height)	≥ 940mm
台面最低 (Min Height)	≤ 700mm
升距 (Adjust)	≥ 240mm



头部操纵式综合手术台（3008F型）

Multi-purpose Operating Table, Head controlled (Model 3008F)

3008F型头部操纵式综合手术台能适应头、颈、胸腹腔、会阴及四肢等外科及妇产科、泌尿科、五官科等手术需要。产品采用丝杆传动和气缸控制台面的各种动作，调节位置操纵方便，迅速安全。床垫均为采用新型耐酸碱，易消毒材料。

3008F operating table can be used in the operations like to head, neck, chest and abdominal cavity, perineum and limbs surgeries, obstetrics and gynecology, urology, ENT and other surgeries. Products with pole transmission and all movements controlled by cylinder. Adjusting position is Convenient, fast and safe. Mattress is manufactured with anti-acid and alkali material.

3008F型



主要规格 (Specifications)

长 (Length)	2040mm
宽 (Width)	500mm
台面最高 (Max Height)	≥ 990mm
台面最低 (Min Height)	≤ 750mm
升距 (Adjust)	≥ 240mm



头部操纵式综合手术台 (3008B,3008B-I, 3008C, 3008A, 3008AB型)

Multi-purpose Operating Table,Head controlled (Model 3008B,3008B-I, 3008C, 3008A, 3008AB)

本产品供医院手术室施行头、颈、胸腹腔、会阴及四肢等外科及妇产科、五官科、骨科等手术。采用油泵升降,手术时所需体位调整均在台面头部操纵。3008A型、3008AB型采用双层塑料台面,可在手术时进行X射线检查,腿板可外展开90°及拆卸,十分便于泌尿科手术。该产品获江苏省优质产品证书。3008B型、3008AB型底盘罩、内外罩为不锈钢。

This table is designed for surgical procedures of the head, neck, thorax and abdomen, And extremities as well as for gynaecological, oto-rhino-laryngological and orthopaedics operations.It can be raised or lowered hydraulically by means of an oil pump. Various positions can be controlled on the head. Model 3008A and 3008AB,made of double decker plastic,X-ray examination can be available during the operation. Leg section can be opened 90° and disassemble. It is most for the urological operation. It was awarded "High Quality Product" certificated by Jiangsu Province. Chassis inside & outside cover of model 3008B and 3008AB are stainless steel.

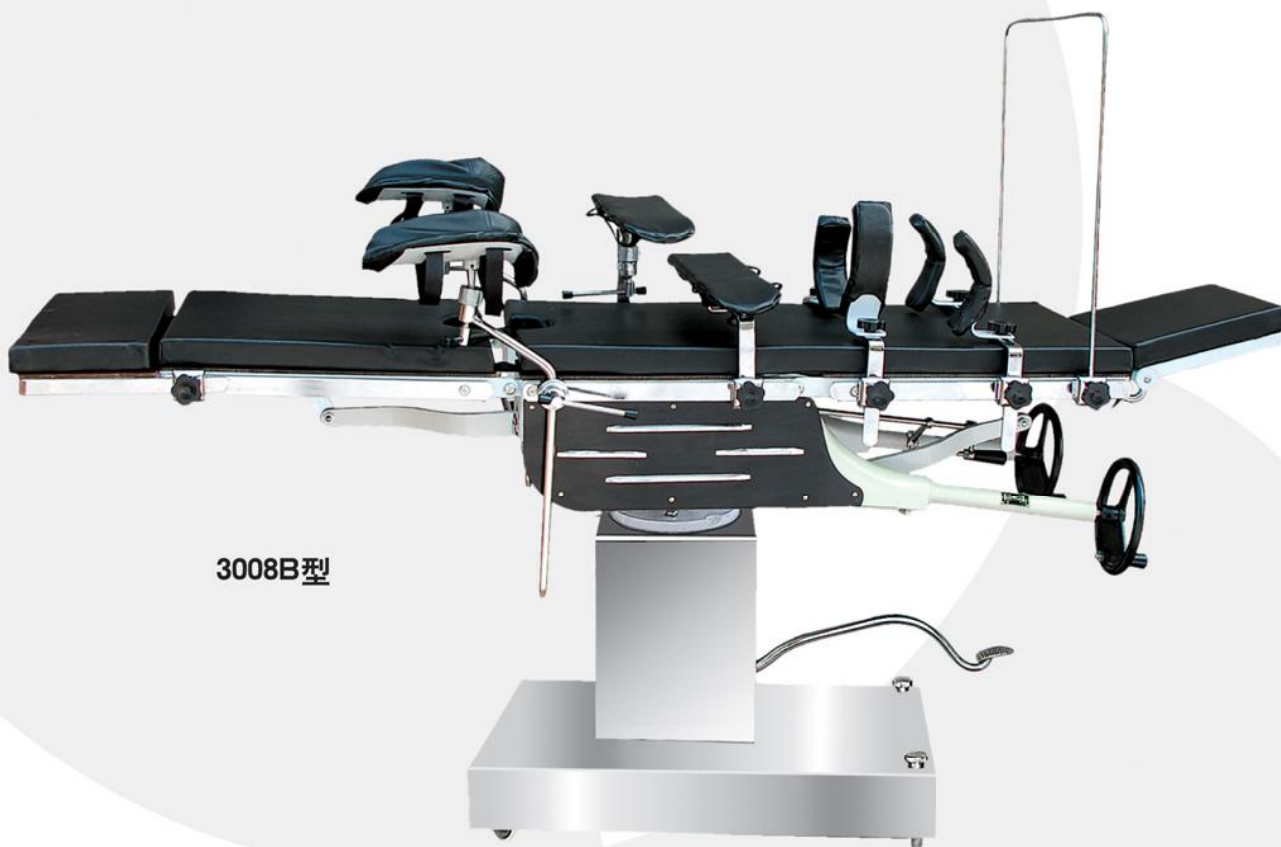

3008B型

主要规格 (Specifications)

长 (Length)	2040mm
宽 (Width)	480mm
高 (Height)	800 - 1040mm

世界在变，创新不变！

CREATIVITY IS ETERNAL, BUT THE WORLD IS CHANGING.

3008AB型

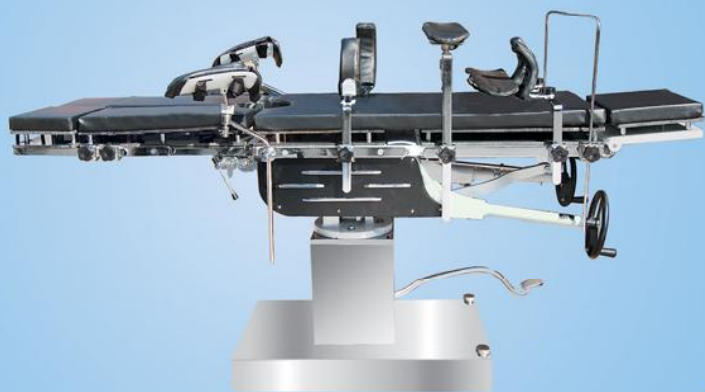

3008A型

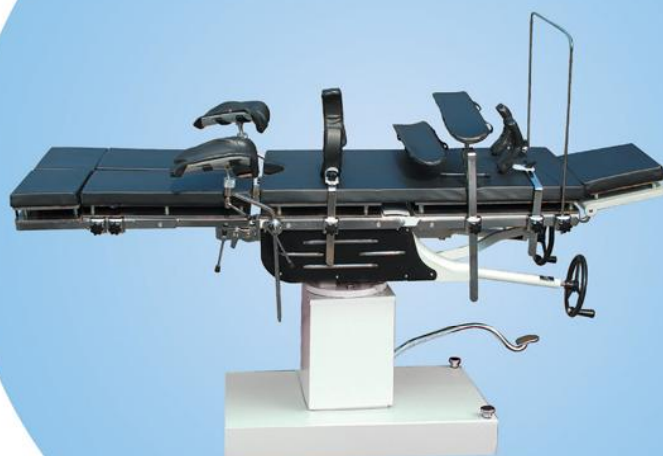

3008B-1型



3008C型





侧面操纵式综合手术台(3001E型)

Multi-purpose Operating table, Side – controlled (Model 3001E)

本产品供医院手术室施行头、颈、胸腹腔、会阴及四肢等外科及妇产科、五官科、骨科等手术，台面升降、前后倾、左右倾由液压系统完成，背板升降应用高压气体阻尼缸支撑结构，该床整个操作系统灵活、简便。全密封底座，造型美观大方，防尘防水，稳定实用，底座造型便于医师靠近患者，减少工作疲劳。台面板采用高强度合成板制成，能透过X射线，便于透视、摄影。腰板为内置式，使用方便。床垫均为采用新型耐酸碱，易消毒材料。

This table is designed for surgical procedures of the head, neck, thorax and abdomen, and extremities as well as for department of obstetrics and gynecology, five sense organs, orthopaedics and so on operations. The table board movements, the front and back lean and the left and right lean are carry on hydraulically by the mean of oil pump, the backboard is raised and lowered by the high pressure gas cylinder. It is easy to operate. It have the airproof pedestal, beautiful shape, waterproof and dustproof function, and it is stable and practical, the pedestal mode is easy for physicians to close to sufferer and reduce fatigue. The table panel is made of high-strength synthetic panels, can through the X-ray, the perspective and photography is easy. Built in waist section is easy to use. Mattress is manufactured with anti-acid and alkali material.



3001E型

主要规格 (Specifications)

长 (Length)	2100mm
宽 (Width)	500mm
高 (Height)	700 – 1000mm
行程 (Adjust)	≥300mm

世界在变，创新不变！

CREATIVITY IS ETERNAL, BUT THE WORLD IS CHANGING.



侧面操纵式综合手术台(3002型)

Multi-purpose Operating table, Side – controlled (Model 3002)

本产品供医院手术室施行头、颈、胸腹腔、会阴及四肢等外科及妇产科、五官科、骨科等手术。台面可上下升降及前后、左右倾，腿板既可折转、外展又可拆卸，调节方便，十分便利泌尿科手术；台面可作前后移动，且全部采用高强度合成板制成，可进行X射线诊查。采用油泵液压升降，手术时所需体位调整均在台面两侧操纵。油泵内外罩及底座罩为不锈钢。

This table is suitable for surgical procedures of the head ,neck, thorax, abdomen, perineum and extremities as well as for gynaecological, oto-rhino-laryngological and orthopaedics operation. The table's elevation, lowering, reversed trendelenburg, trendelenburg, lateral tilt can be all automatically controlled. Leg section can be rotated , opened, disassembled and adjusted easily. It is most suitable for the urological operation. The table top made of high strength glass , can move backwards and forwards. X-Ray examination can be carried out on it. It can be raised or lowered hydraulically by means of an oil pump. Various positions can be controlled from both sides. Chassis inside and outside covers are stainless steel.

3002型

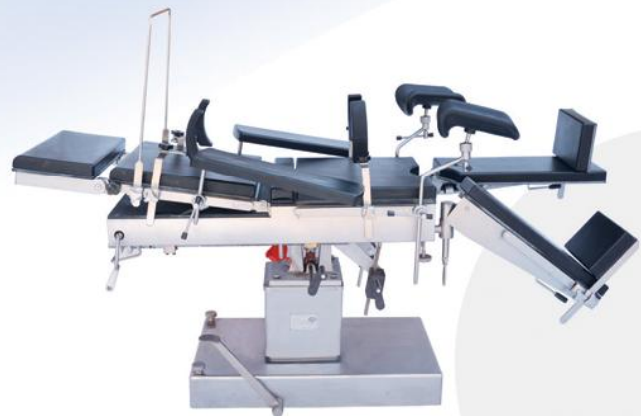

主要规格 (Specifications)

床面长度 (Length)	2100mm
床面宽度 (Width)	500mm
床面最高 (Max Height)	950mm
床面最低 (Min Height)	750mm
升距 (Adjust)	≥200mm 可自由升降、锁定



侧面操纵式综合手术台(3001A型, 3001B型, 3001C型, 3001D型)

Multi-purpose Operating table, Side - controlled (Model 3001A, 3001B, 3001C, 3001D)

本产品供医院手术室施行头、颈、胸腹腔、会阴及四肢等外科及妇产科、五官科、骨科等手术。采用油泵液压升降,手术时所需体位调整均在台面两侧操纵。该产品在全国同类产品质量考核评比中获第一名,获国家医药管理局优质产品证书。3001B型、3001C型底盘罩及内外罩为不锈钢,3001D型可根据用户需求选配不锈钢或优质碳钢表面喷塑罩壳。

This table is suitable for surgical procedures of the head, neck, thorax, abdomen, perineum and extremities as well as for gynaecological, oto-rhino-laryngological and orthopaedics operation. It can be raised or lowered hydraulically by means of an oil pump. Various positions can be controlled from both side. It has been awarded the first prize in China. It has won the "High Quality Product" certificate of the State Pharmaceutical Administration Department. Chassis inside & outside cover of model 3001B and model 3001C are stainless steel, Stainless steel or qualitative carbon steel with plastic-sprayed surface is optional for the chassis inside & outside cover of model 3001D.



世界在变，创新不变！

CREATIVITY IS ETERNAL, BUT THE WORLD IS CHANGING.

3001D型



3001A型



主要规格 (Specifications)

长 (Length)	2100mm
宽 (Width)	480mm
高 (Height)	800-1040mm
高 (Height)	710-910mm (3001D型)



普通手术台(BS型、B型)

Ordinary Operating Table (Model BS, B)

本产品供医院手术室施行头、颈、胸腹腔、会阴及四肢等外科、妇产科、五官科、骨科等手术用。具有综合多能、轻便灵活、实用价廉的特点。BS型底盘罩及内外罩为不锈钢。

This table is designed for surgical procedures of the head, neck, thorax and abdomen, And extremities as well as for gynaecological, oto-rhino-laryngological and orthopaedics operations. It is characterized by versatility, easy operation, good quality and low price. Chassis inside & outside cover of model BS are stainless steel.



BS型

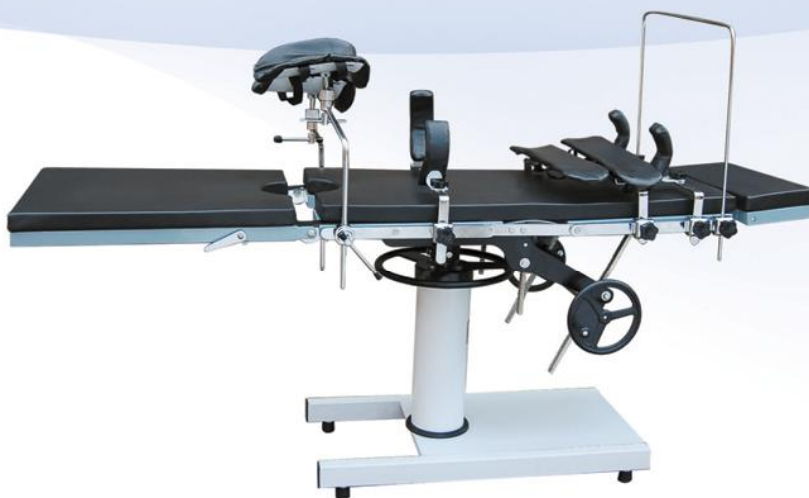

B型

主要规格 (Specifications)

长 (Length)	2000mm
宽 (Width)	480mm
高 (Height)	750~1000mm

世界在变，创新不变！

CREATIVITY IS ETERNAL, BUT THE WORLD IS CHANGING.



普通手术台(B1型、B1S型)

Ordinary Operating Table (Model B1, B1S)

本产品供医院手术室施行头、颈、胸腹腔、会阴及四肢等外科、妇产科、五官科、骨科等手术用。具有综合多能、轻便灵活、实用价廉的特点。B1S型为不锈钢。

This table is designed for surgical procedures of the head, neck, thorax and abdomen, And extremities as well as for gynaecological, Oto-rhino-laryngological and orthopaedics operations. It is characterized by versatility, easy operation, good quality and low price. Model B1S is stainless steel.



B1S型



B1型

主要规格 (Specifications)

长 (Length)	1950mm
宽 (Width)	480mm
高 (Height)	750mm



眼科手术台(99型、99A型)

Ophthalmology Operating Table (Model 99、99A)

该产品是根据医院临床要求而开发的一种适合于眼科手术的产品。该手术台的最低高度为530mm。适合医务人员手术时坐姿操作，并设有可调节任意位置的搁手板，可以降低医务人员的疲劳。手术台台面采用液压升降，头板采用丝杆机构升降，结构新颖，操作方便，性能可靠，是眼科手术的理想产品。

Ophthalmology Operating Table is a new product designed specially for ophthalmology operation, which meets the need of hospital clinical demands. This operating table can be lowered to 530mm, which is convenient for the doctors during the procedure of the surgery. The table is equipped with hand rest for decreasing physical fatigue of doctor. And, top of the table can be raised or lowered hydraulically by means of an oil pump. The apparatus of leading screws elevates head part. Its configuration is fresh, and it can be easily adjusted. Easy operation is one of its features. This table is ideal equipment for ophthalmology operation.

99型



主要规格 (Specifications)

长 (Length)	1950mm
宽 (Width)	550mm
高 (Height)	530 - 780mm
头板升降行程 (Distance of Head section going up and down)	100mm
包装体积 (Volume)	140 × 76 × 87cm



99A型